

# Работа на канала 4В с пучком Li

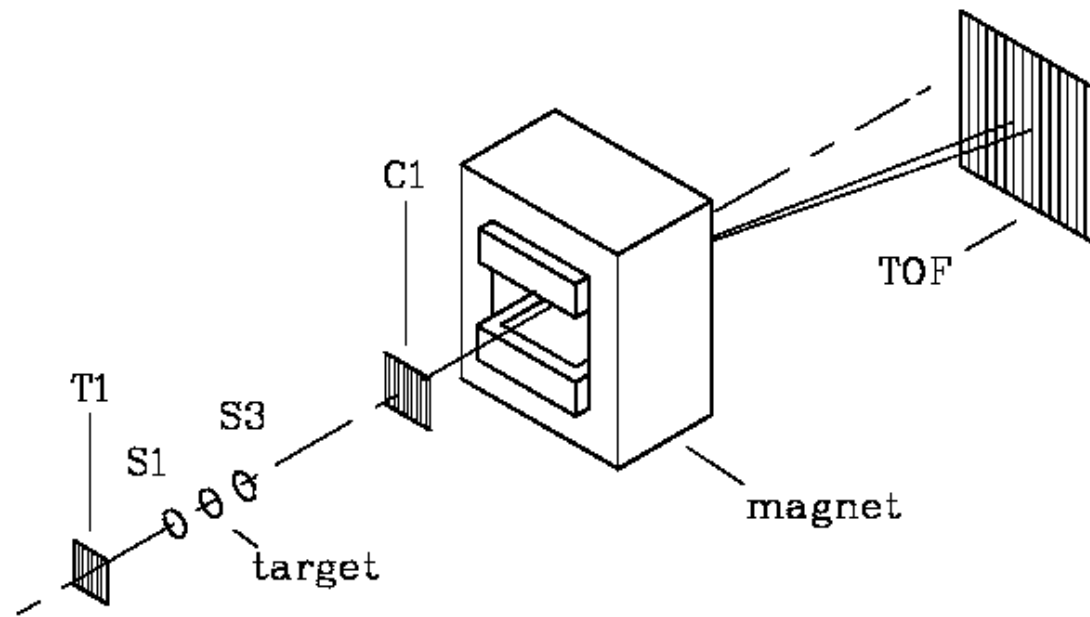

**Афанасьев С.В.**

Рабочее  
совещание

30 ноября 2004



# Run-6 target - Pb

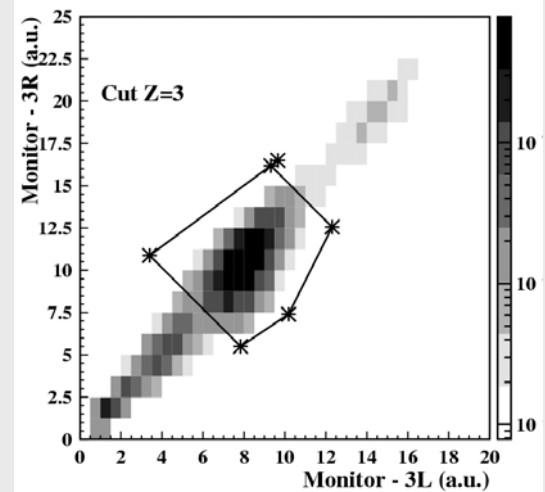
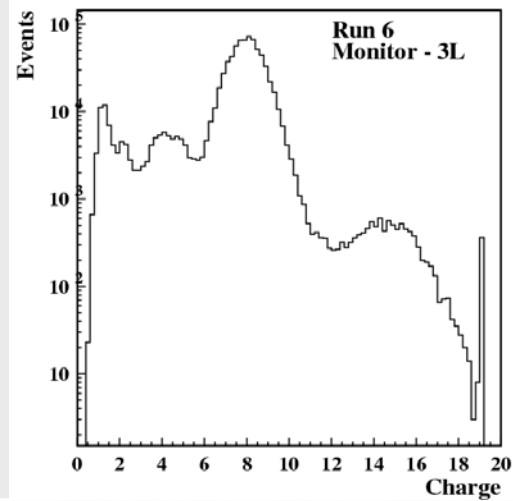
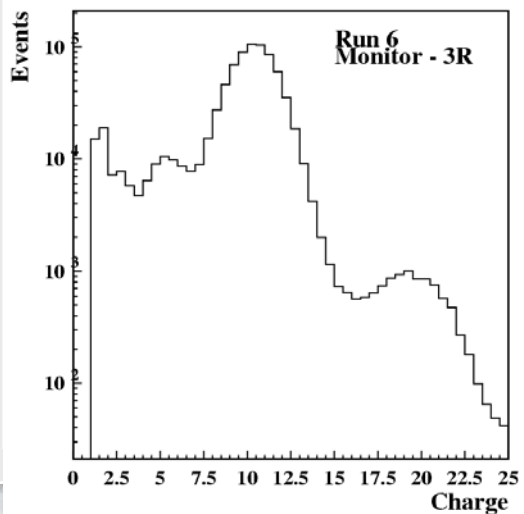
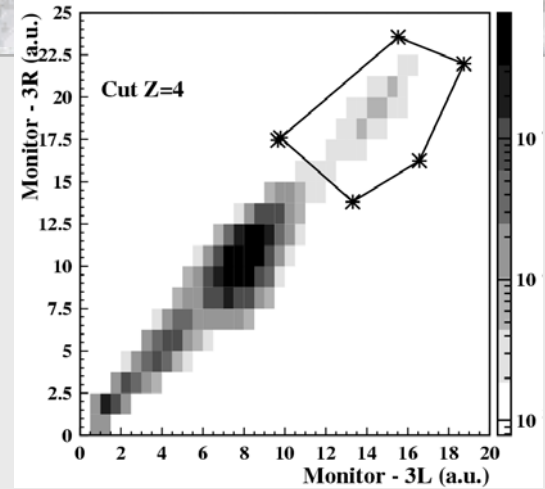
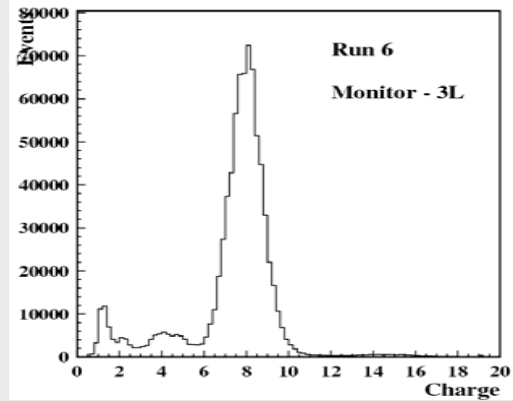
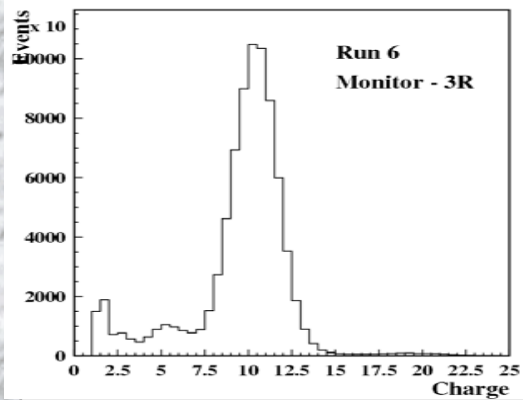

# Run-6 target - Pb

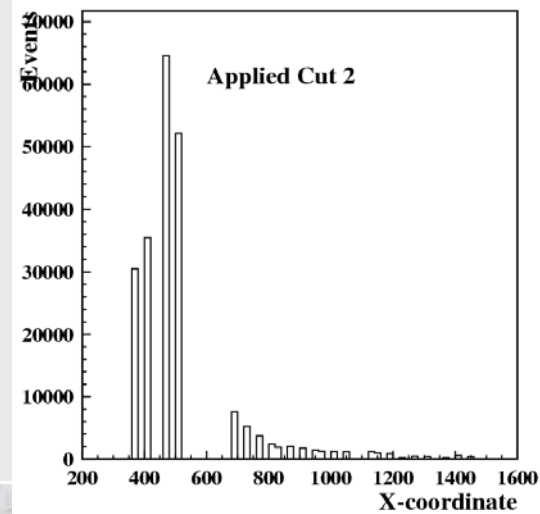
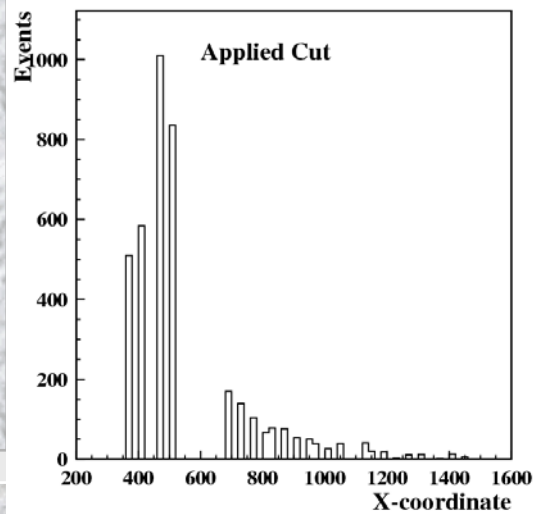
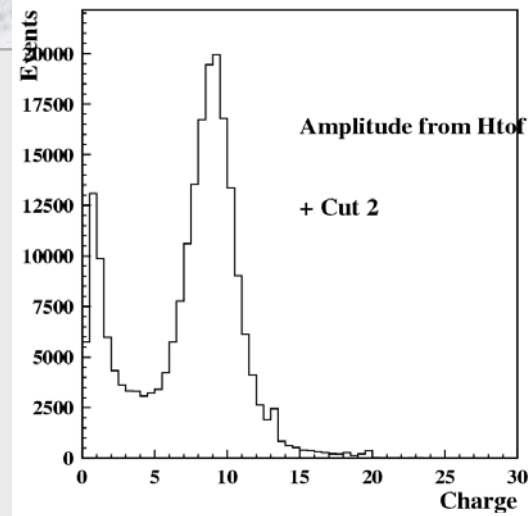
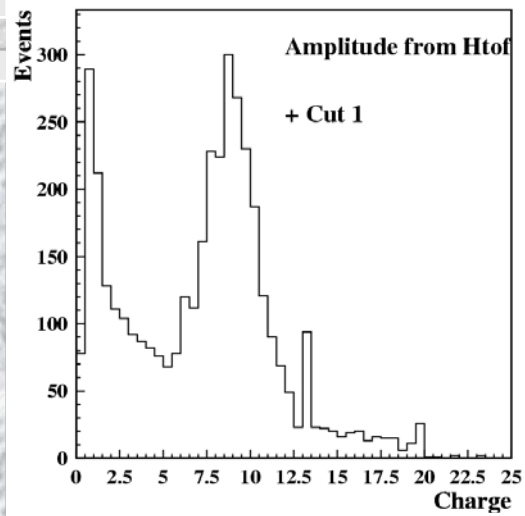

# Run-7 target - Pb

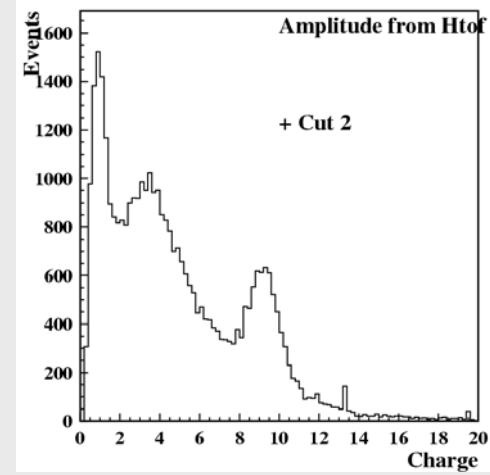
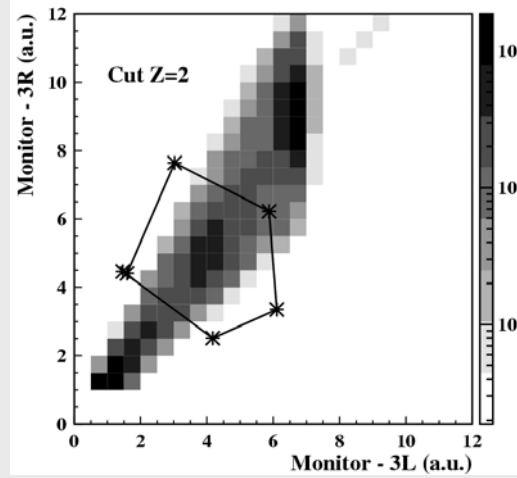
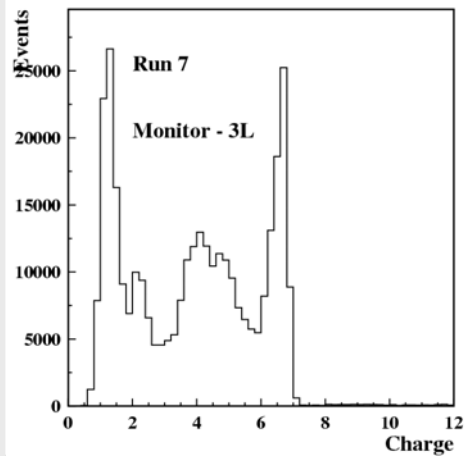
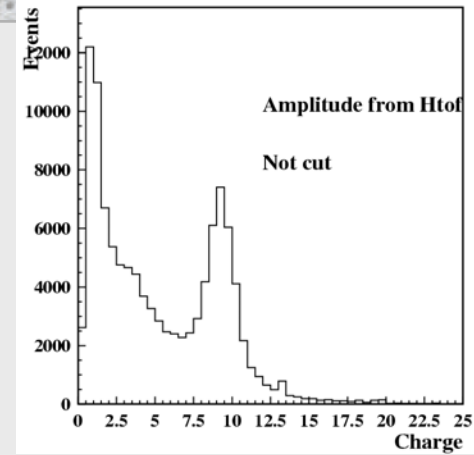
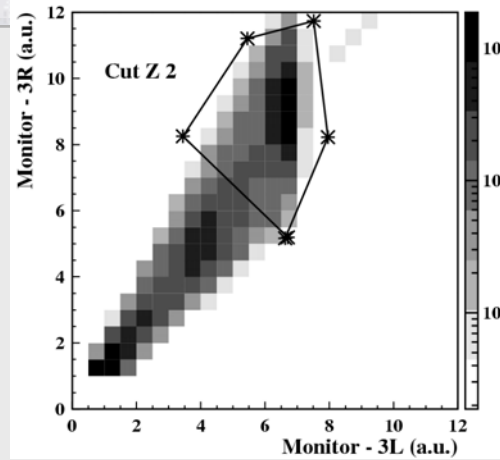
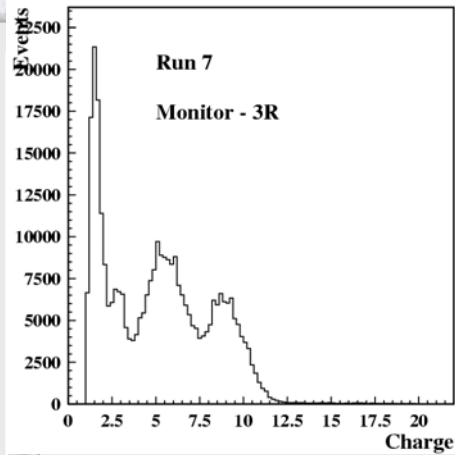

# Run-7 Target - Pb

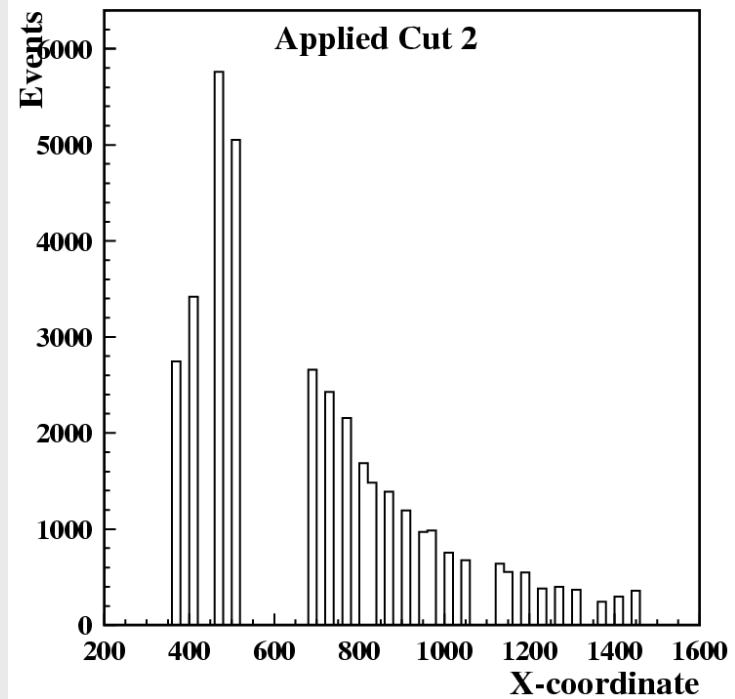
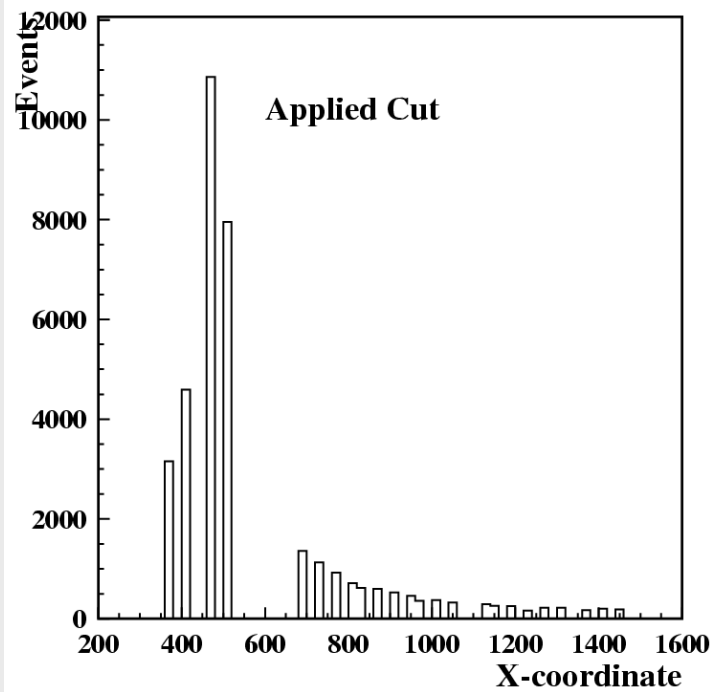

# Run-9 Target - empty

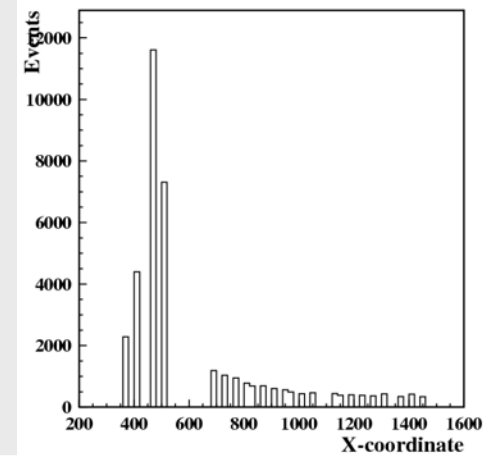
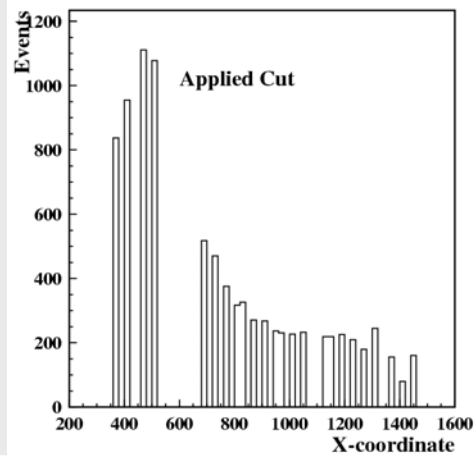
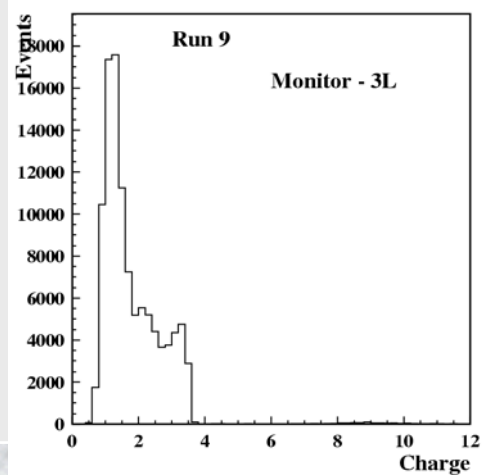
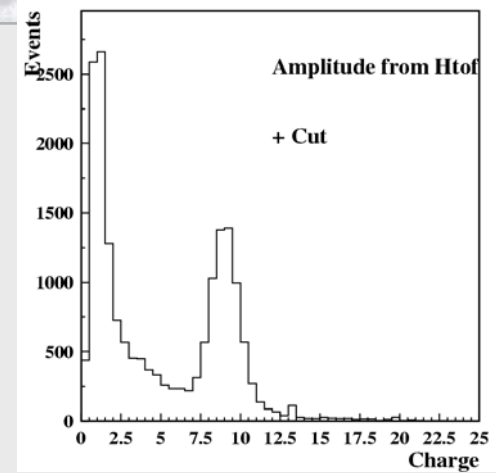
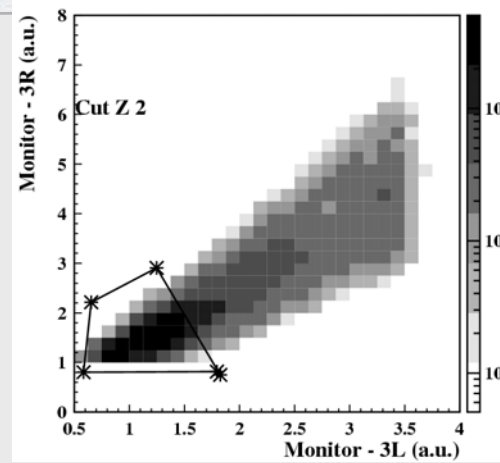
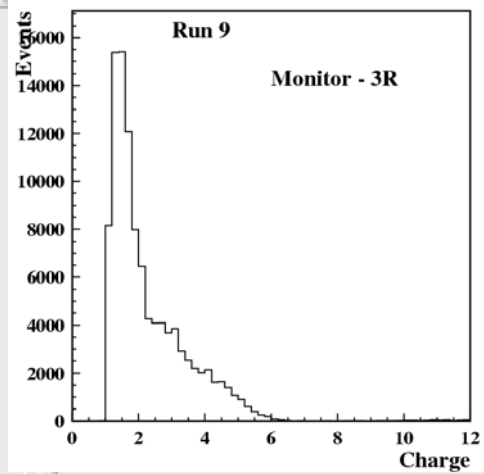

# Run-12 empty target

